

## DS-2CD1023G0-I 2.0 MP IR Network Bullet Camera



### Key Features

- 1/2.8" progressive scan CMOS
- 1920 × 1080@30fps
- 2.8 mm/4 mm/6 mm fixed lens
- H.265+, H.265, H.264+, H.264
- Dual stream
- Digital WDR (Wide Dynamic Range)
- 3D DNR (Digital Noise Reduction)
- Up to 30 m IR range
- PoE (Power over Ethernet)
- IP67



## Specification

<b>Camera</b>	
Image Sensor	1/2.8" progressive scan CMOS
Min. Illumination	Color: 0.01 Lux @(F1.2, AGC ON), 0.028Lux @( F2.0, AGC ON)
Shutter Speed	1/3 s to 1/100, 000 s
Slow Shutter	Yes
Auto-Iris	No
Day &Night	IR cut filter
Digital Noise Reduction	3D DNR
WDR	Digital WDR
Angle Adjustment (Bracket)	Pan: 0° to 360°, tilt: 0° to 180°, rotation: 0° to 360°
<b>Lens</b>	
Focal length	2.8 mm, 4 mm, 6 mm
Aperture	F2.0
Focus	No
FOV	2.8 mm, horizontal FOV 103°, vertical FOV 59°, diagonal FOV 118° 4 mm, horizontal FOV 86°, vertical FOV 46°, diagonal FOV 102° 6 mm, horizontal FOV 54°, vertical FOV 30°, diagonal FOV 62°
Lens Mount	M12
<b>IR</b>	
IR Range	Up to 30 m
Wavelength	850 nm
<b>Compression Standard</b>	
Video Compression	Main stream: H.265/H.264 Sub stream: H.265/H.264/MJPEG
H.264 Type	Baseline Profile/Main Profile/High Profile
H.264+	Main stream supports
H.265 Type	Main Profile
H.265+	Main stream supports
Video Bit Rate	32 Kbps to 8 Mbps
<b>Smart Feature-set</b>	
Region of Interest	1 fixed region for main stream and sub-stream
<b>Image</b>	
Max. Resolution	1920 × 1080
Main Stream Max. Frame Rate	50Hz: 25fps (1920 × 1080, 1280 × 960, 1280 × 720) 60Hz: 30fps (1920 × 1080, 1280 × 960, 1280 × 720)
Sub-stream Max. Frame Rate	50Hz: 25fps (640 × 480, 640 × 360, 320 × 240) 60Hz: 30fps (640 × 480, 640 × 360, 320 × 240)
Image Enhancement	BLC, 3D DNR
Image Setting	Saturation, brightness, contrast, sharpness, AGC, white balance adjustable by client software or web browser
Day/Night Switch	Auto, scheduled
<b>Network</b>	
Alarm Trigger	Motion detection, video tampering alarm, illegal login
Protocols	TCP/IP, ICMP, HTTP, HTTPS, FTP, DHCP, DNS, DDNS, RTP, RTSP, RTCP, NTP, UPnP, SMTP, IGMP, 802.1X, QoS, IPv6, UDP, Bonjour
General Function	Anti-flicker, heartbeat, mirror, password protection, privacy mask, watermark
Firmware Version	5.5.2

API	ONVIF (PROFILE S, PROFILE G), ISAPI
Simultaneous Live View	Up to 6 channels
User/Host	Up to 32 users 3 levels: Administrator, Operator, and User
Client	iVMS-4200, Hik-Connect, iVMS-5200
Web Browser	IE7+, Chrome18-42, Firefox5.0+, Safari5.02+
<b>Interface</b>	
Communication Interface	1 RJ45 10M/100M self-adaptive Ethernet port
<b>General</b>	
Operating Conditions	-30 °C to 50 °C (-22 °F to 122 °F), humidity: 95% or less (non-condensing)
Power Supply	12 VDC ± 25%, 5.5 mm coaxial power plug PoE (802.3af, class 3)
Power Consumption and Current	12 VDC, 0.4 A, Max: 5 W PoE: (802.3af, 36 V to 57 V), 0.2 A to 0.13 A, Max: 7 W
Protection Level	IP67 TVS 2000V lightning protection, surge protection and voltage transient protection
Material	Metal & Plastic
Dimensions	Camera: Ø 70 mm × 172.7mm ( 2.7" × 6.8") With package: 216 mm × 121 mm × 118 mm (8.5" × 4.8" × 4.6")
Weight	Camera: Approx. 280 g (0.62 lb.) With package: Approx. 530 g (1.17 lb.)

## Available Model

DS-2CD1023G0-I (2.8 mm), DS-2CD1023G0-I (4 mm), DS-2CD1023G0-I (6 mm)

**Dimension**

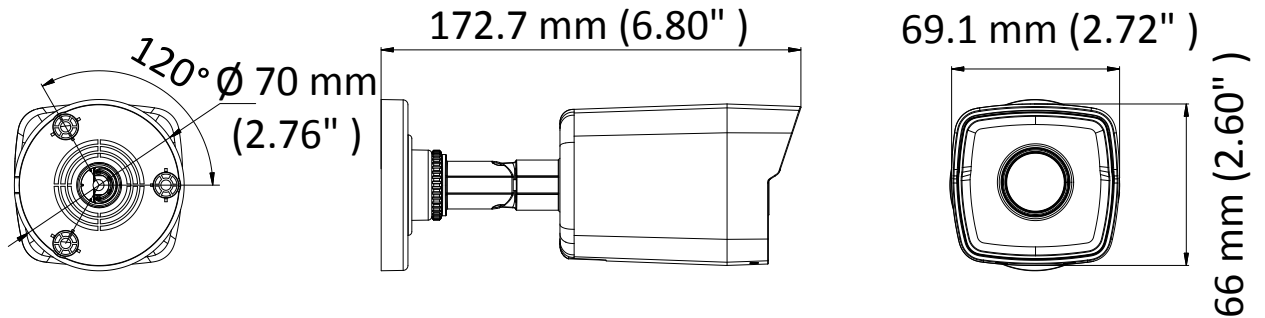

**Accessory**



**DS-1280ZJ-XS  
Junction Box**

Distributed by



**HIKVISION**

**Headquarters**

No.555 Qianmo Road, Binjiang District,  
Hangzhou 310051, China  
T +86-571-8807-5998  
overseasbusiness@hikvision.com

**Hikvision USA**  
T +1-909-895-0400  
sales.usa@hikvision.com

**Hikvision Italy**  
T +39-0438-6902  
info.it@hikvision.com

**Hikvision Singapore**  
T +65-6684-4718  
sg@hikvision.com

**Hikvision Africa**  
T +27 (10) 0351172  
sale.africa@hikvision.com

**Hikvision Europe**  
T +31-23-55-42-770  
info.eu@hikvision.com

**Hikvision France**  
T +33(0)1-85-330-450  
info.fr@hikvision.com

**Hikvision Oceania**  
T +61-2-8599-4233  
salesau@hikvision.com

**Hikvision Hong Kong**  
T +852-2151-1761

**Hikvision Middle East**  
T +971-4-8816086  
salesme@hikvision.com

**Hikvision Spain**  
T +34-91-737-16-55  
info.es@hikvision.com

**Hikvision Canada**  
T +1-909-895-0400  
sales.usa@hikvision.com

**Hikvision Russia**  
T +7-495-669-67-99  
saleru@hikvision.com

**Hikvision Poland**  
T +48-22-460-01-50  
potland@hikvision.com

**Hikvision Korea**  
T +82-31-731-8841  
sales.korea@hikvision.com

**Hikvision India**  
T +91-22-28469900  
sales@pramahikvision.com

**Hikvision UK**  
T +01628-902140  
support.uk@hikvision.com

**Hikvision Brazil**  
T +55 11 3318-0050  
Latam.support@hikvision.com